

DESIGN FIRST.

# iradic No

**fit interiors**

fit interiors — designed and produced in italy

# Nordic

Italiano	3
English	5
Deutsch	7
Français	9
Español	11

# Nordic

Alberto Manzoni

Bancone modulare con doghe in massello di frassino, struttura in MFC sp.18 mm. Top, piano e fascia inferiore sp.36 mm, con led a luce naturale 4000 k°. Piano di lavoro con n°2 passacavi in metallo.



## Struttura

Finiture



## Doghe

Massello frassino



Naturale



Wengé

## Piano di lavoro

Finiture



Antracite



Cashemire



Nero opaco



Bianco opaco

modulo angolo squadrato  
NOAS76 / NOAS90

modulo terminale SX  
NO09076S / NO09090S

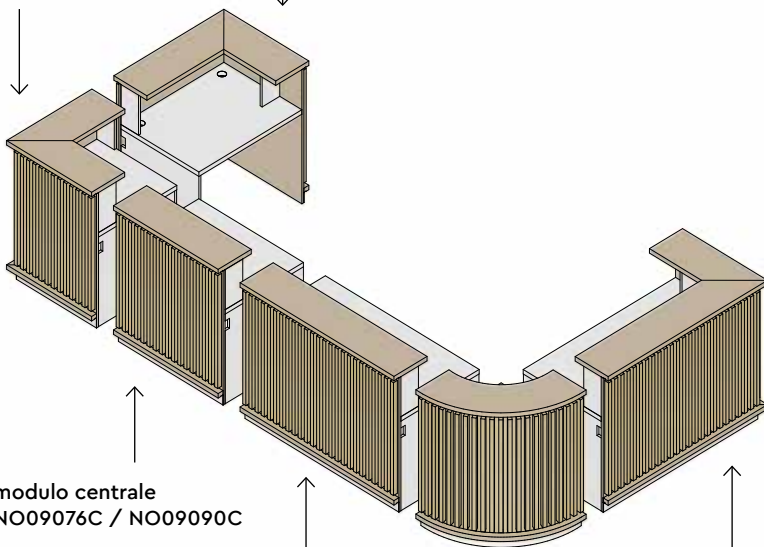

modulo centrale  
NO09076C / NO09090C

modulo centrale  
NO14076C / NO14090C

modulo angolo curvo  
NOAC76 / NOAC90

modulo terminale DX  
NO14076D / NO14090D

Alcune possibili combinazioni

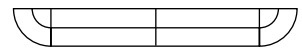

A

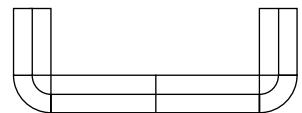

B

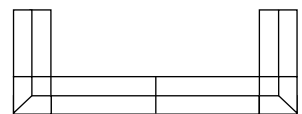

C

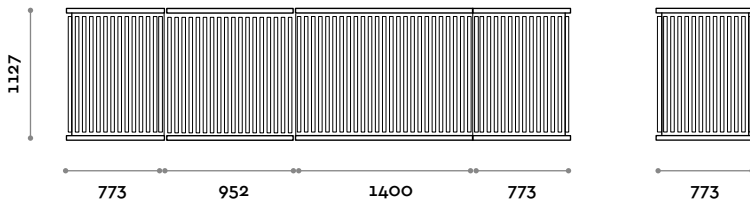

**NO14076S**

Modulo 140 terminale SX. Altezza piano di lavoro 778 mm  
L 1445 mm / P 773 mm / H 1127 mm



**NO14090S**

Modulo 140 terminale SX. Altezza piano di lavoro 918 mm  
L 1445 mm / P 773 mm / H 1127 mm



**NO14076D**

Modulo 140 terminale DX. Altezza piano di lavoro 778 mm  
L 1445 mm / P 773 mm / H 1127 mm



**NO14090D**

Modulo 140 terminale DX. Altezza piano di lavoro 918 mm  
L 1445 mm / P 773 mm / H 1127 mm



**NO14076C**

Modulo 140 centrale. Altezza piano di lavoro 778 mm  
L 1400 mm / P 773 mm / H 1127 mm



**NO14090C**

Modulo 140 centrale. Altezza piano di lavoro 918 mm  
L 1400 mm / P 773 mm / H 1127 mm



**NO09076C**

Modulo 90 centrale. Altezza piano di lavoro 778 mm  
L 952 mm / P 773 mm / H 1127 mm



**NO09090C**

Modulo 90 centrale. Altezza piano di lavoro 918 mm  
L 952 mm / P 773 mm / H 1127 mm



**NO09076S**

Modulo 90 terminale SX. Altezza piano di lavoro 778 mm  
L 997 mm / P 773 mm / H 1127 mm



**NO09090S**

Modulo 90 terminale SX. Altezza piano di lavoro 918 mm  
L 997 mm / P 773 mm / H 1127 mm



**NO09076D**

Modulo 90 terminale DX. Altezza piano di lavoro 778 mm  
L 997 mm / P 773 mm / H 1127 mm



**NO09090D**

Modulo 90 terminale DX. Altezza piano di lavoro 918 mm  
L 997 mm / P 773 mm / H 1127 mm



**NOAS76**

Modulo angolo squadrato. Altezza piano di lavoro 778 mm  
L 773 mm / P 773 mm / H 1127 mm



**NOAS90**

Modulo angolo squadrato. Altezza piano di lavoro 918 mm  
L 773 mm / P 773 mm / H 1127 mm



**NOAC76**

Modulo angolo curvo. Altezza piano di lavoro 778 mm  
L 773 mm / P 773 mm / H 1127 mm



**NOAC90**

Modulo angolo curvo. Altezza piano di lavoro 918 mm  
L 773 mm / P 773 mm / H 1127 mm

# Nordic

Alberto Manzoni

Modular counter with solid ash slats, MFC structure 18 mm thickness. Top, worktop and lower band 36 mm thickness with 4000 k° natural white LED light. Worktop has 2 metal cable grommets.



**Structure**

Finishes



**Slats**

Solid ash wood



**Worktop**

Finishes



square corner module  
NOAS76 / NOAS90

left end module  
NO09076S / NO09090S

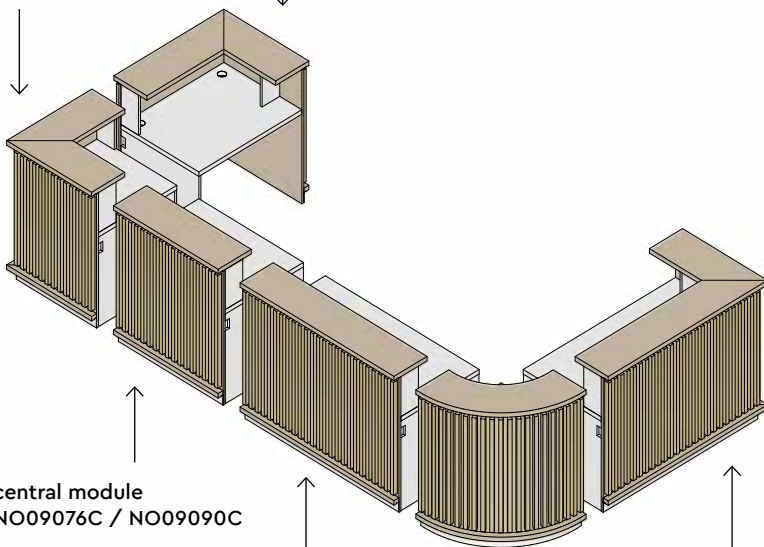

central module  
NO09076C / NO09090C

central module  
NO14076C / NO14090C

curved corner module  
NOAC76 / NOAC90

right end module  
NO14076D / NO14090D

**Example compositions**

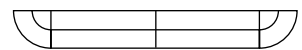

A

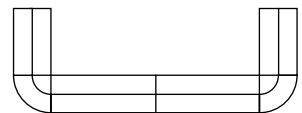

B

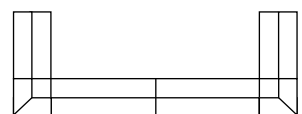

C

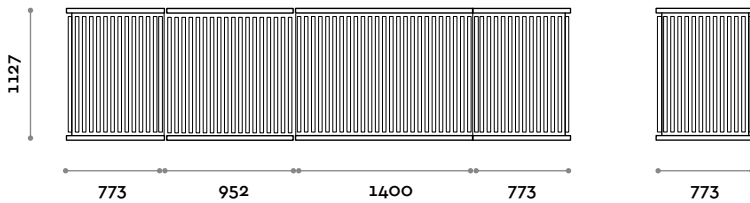

**NO14076S**  
 Left end module 140. Worktop height 778 mm  
 W 1445 mm / D 773 mm / H 1127 mm



**NO14090S**  
 Left end module 140. Worktop height 918 mm  
 W 1445 mm / D 773 mm / H 1127 mm



**NO14076D**  
 Right end module 140. Worktop height 778 mm  
 W 1445 mm / D 773 mm / H 1127 mm



**NO14090D**  
 Right end module 140. Worktop height 918 mm  
 W 1445 mm / D 773 mm / H 1127 mm



**NO14076C**  
 Central module 140. Worktop height 778 mm  
 W 1400 mm / D 773 mm / H 1127 mm



**NO14090C**  
 Central module 140. Worktop height 918 mm  
 W 1400 mm / D 773 mm / H 1127 mm



**NO09076C**  
 Central module 90. Worktop height 778 mm  
 W 952 mm / D 773 mm / H 1127 mm



**NO09090C**  
 Central module 90. Worktop height 918 mm  
 W 952 mm / D 773 mm / H 1127 mm



**NO09076S**  
 Left end module 90. Worktop height 778 mm  
 W 997 mm / D 773 mm / H 1127 mm



**NO09090S**  
 Left end module 90. Worktop height 918 mm  
 W 997 mm / D 773 mm / H 1127 mm



**NO09076D**  
 Right end module 90. Worktop height 778 mm  
 W 997 mm / D 773 mm / H 1127 mm



**NO09090D**  
 Right end module 90. Worktop height 918 mm  
 W 997 mm / D 773 mm / H 1127 mm



**NOAS76**  
 Square corner module. Worktop height 778 mm  
 W 773 mm / D 773 mm / H 1127 mm



**NOAS90**  
 Square corner module. Worktop height 918 mm  
 W 773 mm / D 773 mm / H 1127 mm



**NOAC76**  
 Curved corner module. Worktop height 778 mm  
 W 773 mm / D 773 mm / H 1127 mm



**NOAC90**  
 Curved corner module. Worktop height 918 mm  
 W 773 mm / D 773 mm / H 1127 mm

# Nordic

Alberto Manzoni

Modulare Theke mit Leisten aus Eschen-Massivholz und furnierter Struktur von 18 mm Stärke Top, Arbeitsplatte und unterer Abschlussstreifen von 36 mm Stärke, mit LED für natürliches Licht 4000 K. Arbeitsplatte mit 2 Kabeldurchführungen aus Metall.

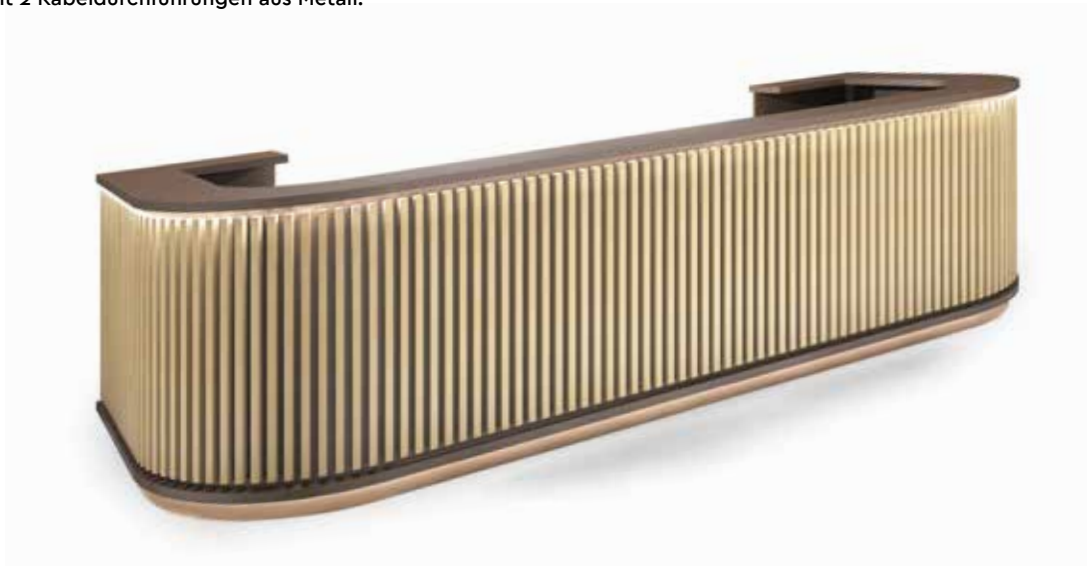

## Struktur

Ausführungen



## Leisten

Eschen-massivholz



## Arbeitsplatte

Ausführungen



abgewinkeltes Eckmodul  
NOAS76 / NOAS90

Abschlussmodul links  
NO09076S / NO09090S

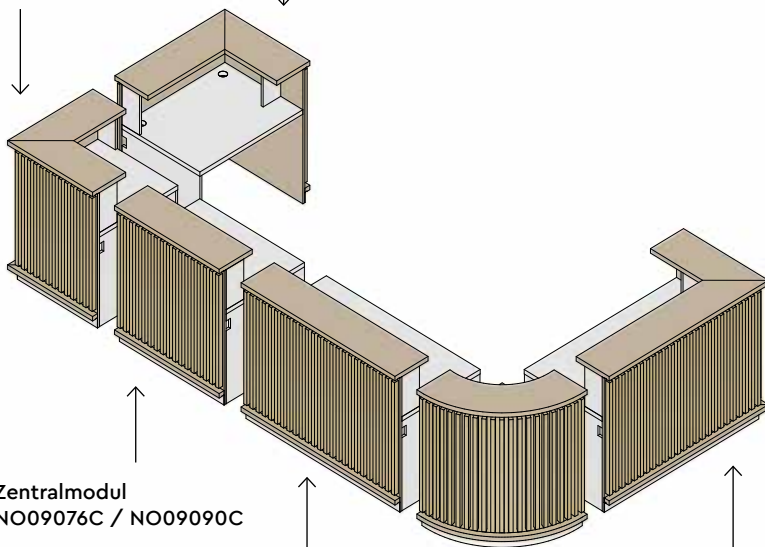

Zentralmodul  
NO09076C / NO09090C

Zentralmodul  
NO14076C / NO14090C

gebogenes Eckmodul  
NOAC76 / NOAC90

Abschlussmodul rechts  
NO14076D / NO14090D

Einige mögliche Kombinationen

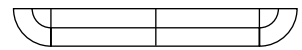

A

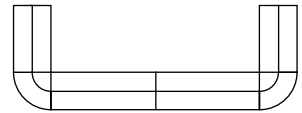

B

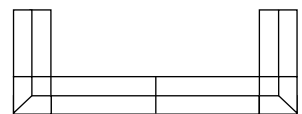

C

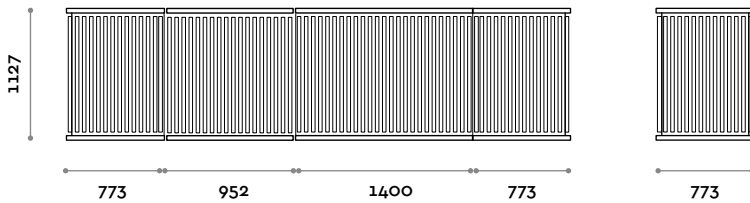
**NO14076S**

Abschlussmodul links 140. Arbeitsplattenhöhe 778 mm  
B 1445 mm / T 773 mm / H 1127 mm

**NO14090S**

Abschlussmodul links 140. Arbeitsplattenhöhe 918 mm  
B 1445 mm / T 773 mm / H 1127 mm

**NO14076D**

Abschlussmodul rechts 140. Arbeitsplattenhöhe 778 mm  
B 1445 mm / T 773 mm / H 1127 mm

**NO14090D**

Abschlussmodul rechts 140. Arbeitsplattenhöhe 918 mm  
B 1445 mm / T 773 mm / H 1127 mm

**NO14076C**

Zentralmodul 140. Arbeitsplattenhöhe mm  
B 1400 mm / T 773 mm / H 1127 mm

**NO14090C**

Zentralmodul 140. Arbeitsplattenhöhe 918 mm  
B 1400 mm / T 773 mm / H 1127 mm

**NO09076C**

Zentralmodul 90. Arbeitsplattenhöhe 778 mm  
B 952 mm / T 773 mm / H 1127 mm

**NO09090C**

Zentralmodul 90. Arbeitsplattenhöhe 918 mm  
B 952 mm / T 773 mm / H 1127 mm

**NO09076S**

Abschlussmodul links 90. Arbeitsplattenhöhe 778 mm  
B 997 mm / T 773 mm / H 1127 mm

**NO09090S**

Abschlussmodul links 90. Arbeitsplattenhöhe 918 mm  
B 997 mm / T 773 mm / H 1127 mm

**NO09076D**

Abschlussmodul rechts 90. Arbeitsplattenhöhe 778 mm  
B 997 mm / T 773 mm / H 1127 mm

**NO09090D**

Abschlussmodul rechts 90. Arbeitsplattenhöhe 918 mm  
B 997 mm / T 773 mm / H 1127 mm

**NOAS76**

Abgewinkelt Eckmodul. Arbeitsplattenhöhe 778 mm  
B 773 mm / T 773 mm / H 1127 mm

**NOAS90**

Abgewinkelt Eckmodul. Arbeitsplattenhöhe 918 mm  
B 773 mm / T 773 mm / H 1127 mm

**NOAC76**

Gebogenes Eckmodul. Arbeitsplattenhöhe 778 mm  
B 773 mm / T 773 mm / H 1127 mm

**NOAC90**

Gebogenes Eckmodul. Arbeitsplattenhöhe 918 mm  
B 773 mm / T 773 mm / H 1127 mm



# Nordic

Alberto Manzoni

Comptoir modulaire avec lattes en frêne massif, structure en mélaminé 18 mm d'épaisseur. Dessus, plan et bande inférieure de 36 mm d'épaisseur, avec led à lumière naturelle 4000 K. Plan de travail avec 2 goulottes en métal.



## Structure

Finitions



## Lattes

Frêne massif



Naturel



Wengé

## Plan de travail

Finitions



Anthracite



Cachemire



Noir mat



Blanc mat

module d'angle carré  
NOAS76 / NOAS90

module d'extrémité gauche  
NO09076S / NO09090S

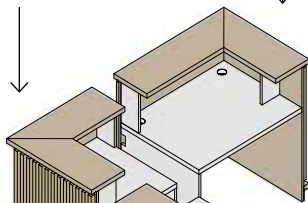

module central  
NO09076C / NO09090C

module central  
NO14076C / NO14090C

module d'angle courbe  
NOAC76 / NOAC90

module d'extrémité droit  
NO14076D / NO14090D

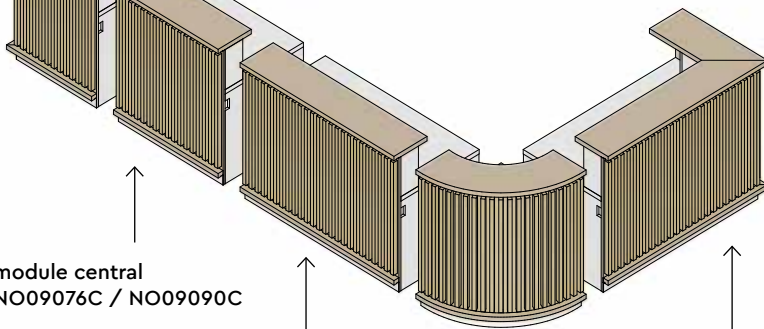

Quelques combinaisons possibles

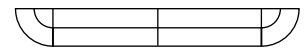

A

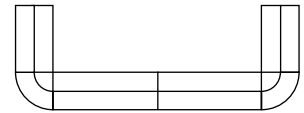

B

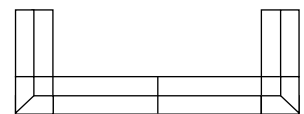

C

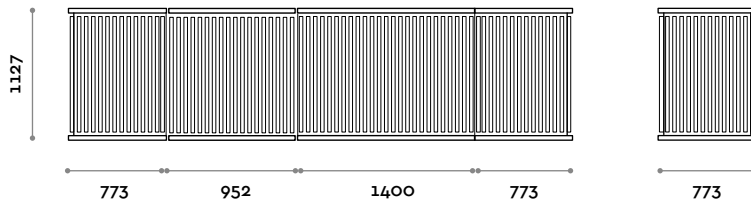
**NO14076S**

Module d'extrémité gauche 140. Hauteur du plan de travail 778 mm  
L 1445 mm / P 773 mm / H 1127 mm

**NO14090S**

Module d'extrémité gauche 140. Hauteur du plan de travail 918 mm  
L 1445 mm / P 773 mm / H 1127 mm

**NO14076D**

Module d'extrémité droite 140. Hauteur du plan de travail 778 mm  
L 1445 mm / P 773 mm / H 1127 mm

**NO14090D**

Module d'extrémité droite 140. Hauteur du plan de travail 918 mm  
L 1445 mm / P 773 mm / H 1127 mm

**NO14076C**

Module central 140. Hauteur du plan de travail 778 mm  
L 1400 mm / P 773 mm / H 1127 mm

**NO14090C**

Module central 140. Hauteur du plan de travail 918 mm  
L 1400 mm / P 773 mm / H 1127 mm

**NO09076C**

Module central 90. Hauteur du plan de travail 778 mm  
L 952 mm / P 773 mm / H 1127 mm

**NO09090C**

Module central 90. Hauteur du plan de travail 918 mm  
L 952 mm / P 773 mm / H 1127 mm

**NO09076S**

Module d'extrémité gauche 90. Hauteur du plan de travail 778 mm  
L 997 mm / P 773 mm / H 1127 mm

**NO09090S**

Module d'extrémité gauche 90. Hauteur du plan de travail 918 mm  
L 997 mm / P 773 mm / H 1127 mm

**NO09076D**

Module d'extrémité droite 90. Hauteur du plan de travail 778 mm  
L 997 mm / P 773 mm / H 1127 mm

**NO09090D**

Module d'extrémité droite 90. Hauteur du plan de travail 918 mm  
L 997 mm / P 773 mm / H 1127 mm

**NOAS76**

Module d'angle carré. Hauteur du plan de travail 778 mm  
L 773 mm / P 773 mm / H 1127 mm

**NOAS90**

Module d'angle carré. Hauteur du plan de travail 918 mm  
L 773 mm / P 773 mm / H 1127 mm

**NOAC76**

Module d'angle courbe. Hauteur du plan de travail 778 mm  
L 773 mm / P 773 mm / H 1127 mm

**NOAC90**

Module d'angle courbe. Hauteur du plan de travail 918 mm  
L 773 mm / P 773 mm / H 1127 mm

# Nordic

Alberto Manzoni

Mostrador modular con duelas de madera maciza de fresno, estructura de ennoblecido grosor 18 mm. Top, superficie y faja inferior grosor 36 mm, con led de luz natural 4.000 k°. Encimera con 2 pasacables de metal.



**Estructura**

Acabados



**Duelas**

Madera maciza de fresno



**Encimera**

Acabados



módulo ángulo recto  
NOAS76 / NOAS90

módulo terminal IZQ  
NO09076S / NO09090S

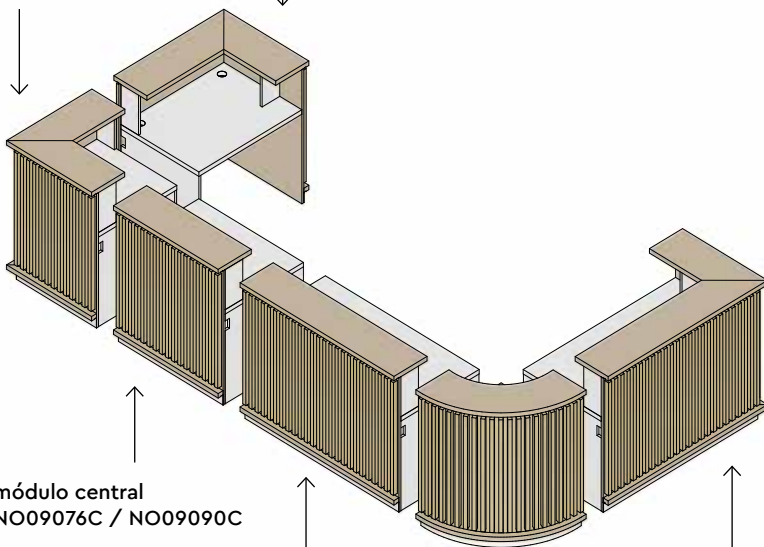

módulo central  
NO09076C / NO09090C

módulo central  
NO14076C / NO14090C

módulo ángulo curvado  
NOAC76 / NOAC90

módulo terminal DCHA  
NO14076D / NO14090D

Varias posibles combinaciones

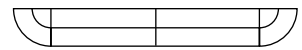

A

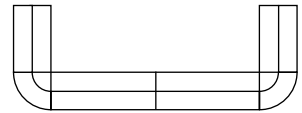

B

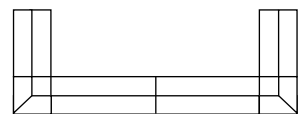

C

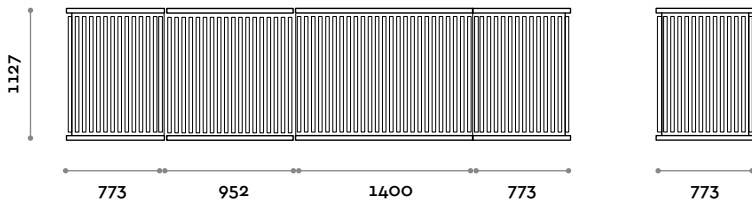

**NO14076S**  
Módulo terminal IZQ 140. Altura encimera 778 mm  
L 1445 mm / P 773 mm / H 1127 mm



**NO14090S**  
Módulo terminal IZQ 140. Altura encimera 918 mm  
L 1445 mm / P 773 mm / H 1127 mm



**NO14076D**  
Modulo terminal DCHA 140. Altura encimera 778 mm  
L 1445 mm / P 773 mm / H 1127 mm



**NO14090D**  
Modulo terminal DCHA 140. Altura encimera 918 mm  
L 1445 mm / P 773 mm / H 1127 mm



**NO14076C**  
Módulo central 140. Altura encimera 778 mm  
L 1400 mm / P 773 mm / H 1127 mm



**NO14090C**  
Módulo central 140. Altura encimera 918 mm  
L 1400 mm / P 773 mm / H 1127 mm



**NO09076C**  
Módulo central 90. Altura encimera 778 mm  
L 952 mm / P 773 mm / H 1127 mm



**NO09090C**  
Módulo central 90. Altura encimera 918 mm  
L 952 mm / P 773 mm / H 1127 mm



**NO09076S**  
Módulo terminal IZQ 90. Altura encimera 778 mm  
L 997 mm / P 773 mm / H 1127 mm



**NO09090S**  
Módulo terminal IZQ 90. Altura encimera 918 mm  
L 997 mm / P 773 mm / H 1127 mm



**NO09076D**  
Modulo terminal DCHA 90. Altura encimera 778 mm  
L 997 mm / P 773 mm / H 1127 mm



**NO09090D**  
Modulo terminal DCHA 90. Altura encimera 918 mm  
L 997 mm / P 773 mm / H 1127 mm



**NOAS76**  
Módulo ángulo recto. Altura encimera 778 mm  
L 773 mm / P 773 mm / H 1127 mm



**NOAS90**  
Módulo ángulo recto. Altura encimera 918 mm  
L 773 mm / P 773 mm / H 1127 mm



**NOAC76**  
Modulo ángulo curvado. Altura encimera 778 mm  
L 773 mm / P 773 mm / H 1127 mm



**NOAC90**  
Modulo ángulo curvado. Altura encimera 918 mm  
L 773 mm / P 773 mm / H 1127 mm

follow us



**fit  
interiors**

**furniture for gyms,  
health and golf clubs,  
spa&wellness, hotel,  
medical and corporate**

**visit** [www.fitinteriors.com](http://www.fitinteriors.com)